

**HOLLOW METAL
DOORS**

METAL DOORS & FRAMES
8d
NAAMM HMMA 810-09

NAAMM HMMA 810-09
8d
METAL DOORS & FRAMES



This Manual was developed by representative members of and approved by the Hollow Metal Manufacturers Association (HMMA) Division of the National Association of Architectural Metal Manufacturers (NAAMM) to provide their opinion and guidance on the basic design of hollow metal doors and frames. This standard contains advisory information only and is published as a public service by NAAMM and its HMMA Division. NAAMM and its HMMA Division disclaim all liability of any kind for the use, application, or adaptation of material published in this standard.

Purchasers of NAAMM Standards may receive current information on all NAAMM Standards by calling or writing the National Association of Architectural Metal Manufacturers.

National Association of Architectural Metal Manufacturers

800 Roosevelt Road

Bldg. C, Suite 312

Glen Ellyn, Illinois 60137

Phone: (630) 942-6591 Fax: (630) 790-3095

www.naamm.org

Copyright © 1977, 1987, 2009

National Association of Architectural Metal Manufacturers

All Rights Reserved

TABLE OF CONTENTS

Part 1 - INTRODUCTION

| | |
|---|---|
| A. General | 3 |
| B. Types of Construction..... | 3 |
| C. Clearance Dimensions and Hardware Locations..... | 4 |
| D. Door Hand Designations..... | 4 |
| E. Door Designs..... | 5 |

Part 2 - CONSTRUCTION FEATURES

| | |
|---|---|
| A. Constructions..... | 5 |
| B. Meeting Edge Profiles..... | 6 |
| C. Stiffener Sections | 6 |
| D. Stile Edge Details..... | 6 |
| E. Top Edge Details | 6 |
| F. Bottom Edge Details..... | 6 |
| G. Top Edge Details with Flush Transom Panel | 6 |
| H. Glazed Opening and Recessed Panel Moldings | 7 |
| I. Muntins | 7 |
| J. Louver Designs | 7 |
| K. Hardware Preparations | 8 |

HOLLOW METAL DOORS

PART 1 - INTRODUCTION

A. General

Doors may be classified by their method of operation. There are four basic types: swinging, sliding, rolling steel, and revolving. Though revolving doors are seldom, if ever, made of carbon steel, sliding and rolling steel may be hollow metal.

This standard applies to hollow metal doors that are side-hinged swinging and mounted on either hinges or pivots

B. Types of Construction

The details shown on the following pages pertain to HMMA door constructions outlined in the following NAAMM/HMMA standard specifications:

- HMMA 860, "Guide Specifications for Hollow Metal Doors and Frames", is used and specified for hollow metal doors and frames subject to less rigorous use than commercial and institutional applications.
- ANSI/HMMA 861, "Guide Specifications for Commercial Hollow Metal Doors and Frames", is used and specified in commercial work is the continuously welded edge seam construction and it is this type that is the basis of the NAAMM Standard.
- ANSI/HMMA 862, "Guide Specifications for Security Hollow Metal Doors and Frames", is used and specified in applications where security against vandalism, break-in, or theft is a major concern.
- ANSI/HMMA 863, "Guide Specifications for Detention Security Hollow Metal Doors and Frames", is used and specified for detention security.
- ANSI/HMMA 865, "Guide Specifications for Swinging Sound Control Hollow Metal Doors and Frames", is used and specified for applications where sound control is a factor.
- ANSI/HMMA 866, "Guide Specifications for Stainless Steel Hollow Metal Doors and Frames", is used and specified when stainless steel is required for corrosion resistance or aesthetics is a factor.
- ANSI/HMMA 867, "Guide Specifications for Commercial Laminated Core Hollow Metal Doors and Frames", is used and specified for doors incorporating the use of laminated cores.

HMMA 850, "Fire rated Hollow Metal Doors and Frames". Since fire rated doors may differ in certain details of construction, refer to HMMA 850, "Fire Rated Hollow Metal Doors and Frames" standard for guidance.

C. CLEARANCE DIMENSIONS & HINGE LOCATIONS

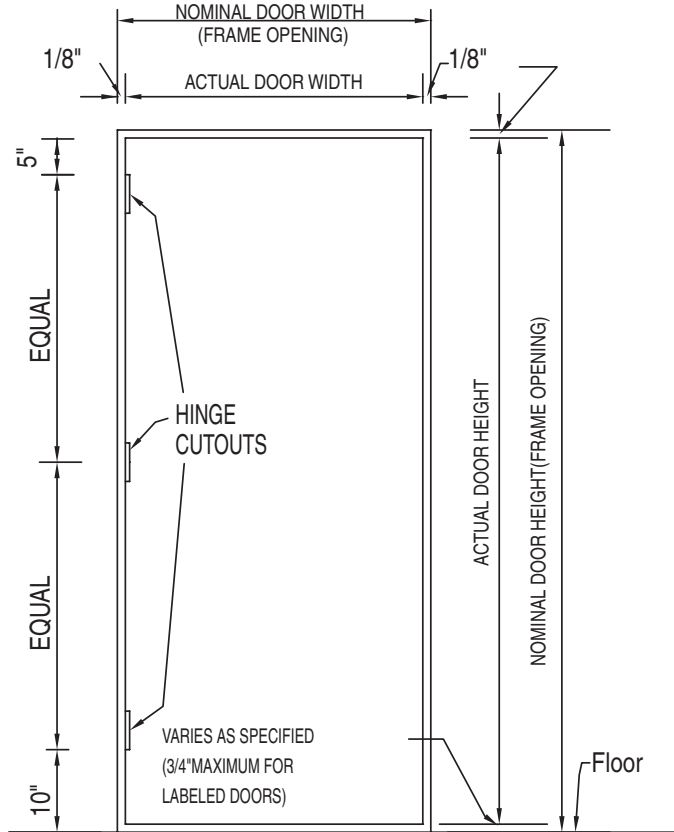

D. DOOR HAND DESIGNATIONS

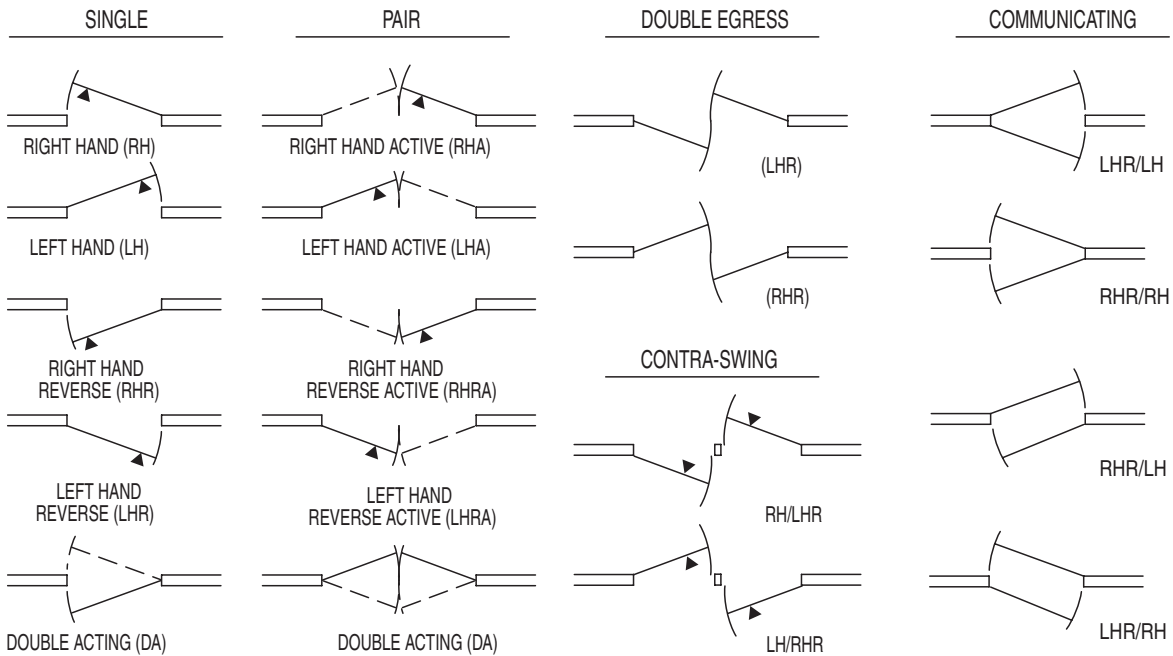

▲ = KEY SIDE

E. DOOR DESIGNS

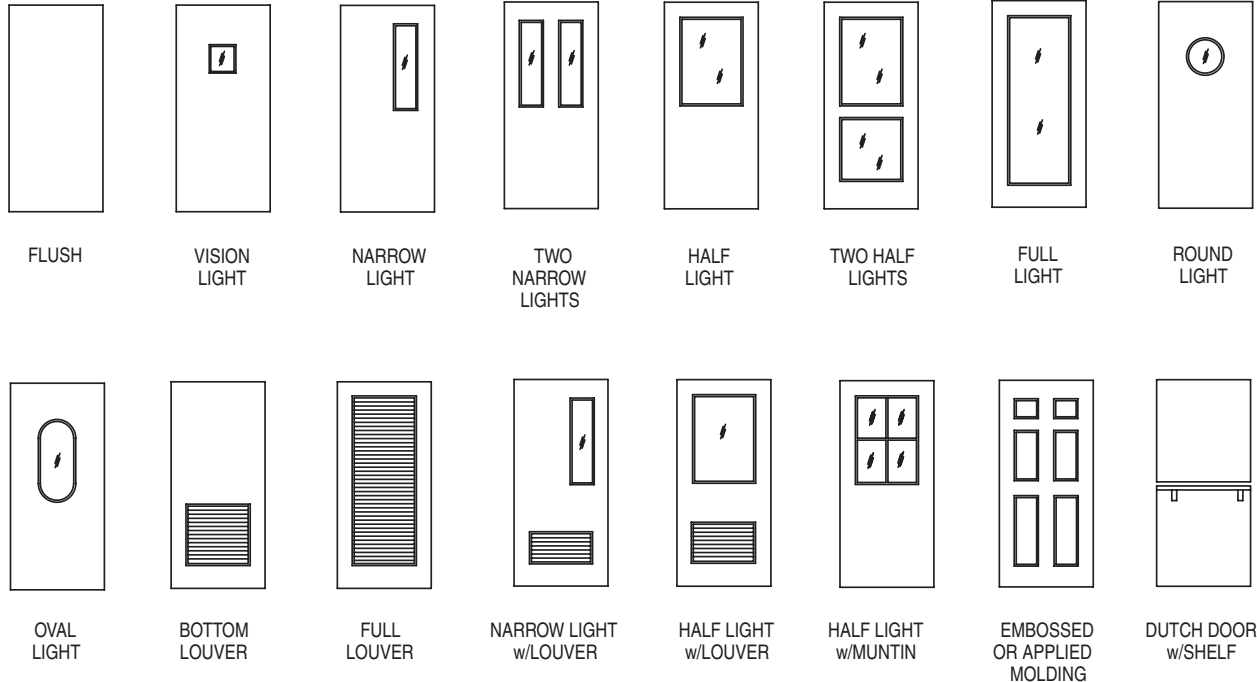

PART 2 - CONSTRUCTION FEATURES

A. Constructions

There are two basic types of door constructions:

- **STEEL STIFFENERS** – Vertical steel stiffeners, which can be channel, zee, hat, or similar shaped sections, support the face sheets. The stiffeners are attached to the face sheets by spot or projection welding.
- **LAMINATED CORE** – This is a sandwich construction in which the face sheets are separated by a core comprised of honeycomb (“Kraft” paper) or polyurethane or polyisocyanurate or polystyrene or core board or steel stiffeners. The core is laminated to the faces by means of an adhesive. Foamed-in-place polyurethane cores are self-bonding and do not require additional adhesive.

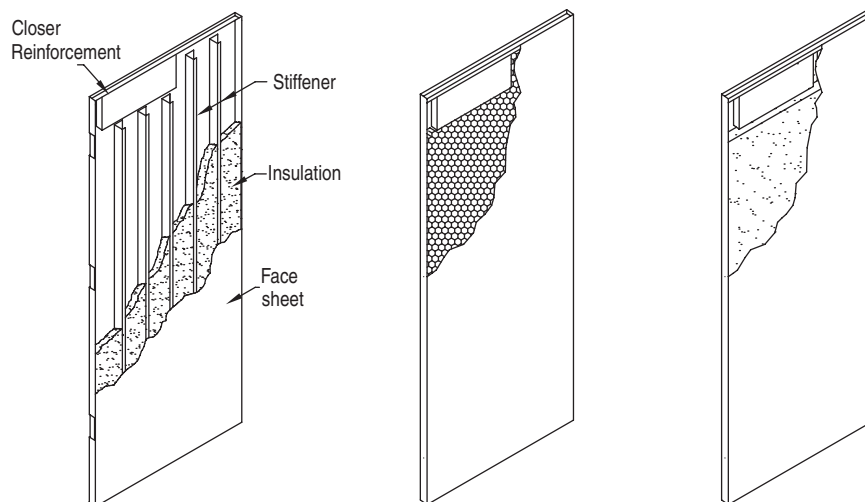

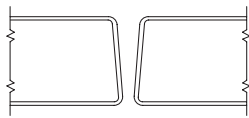

V-BEVEL

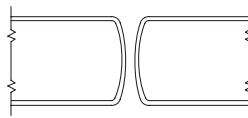

BULLNOSE
USED ON DOUBLE-ACTING
CENTER-PIVOTED DOORS

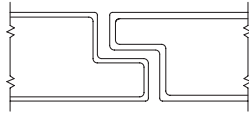

RABBETED

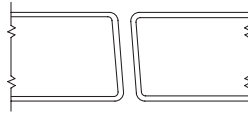

PARALLEL BEVEL

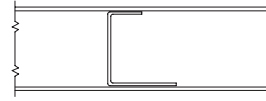

CHANNEL

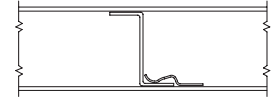

ZEE

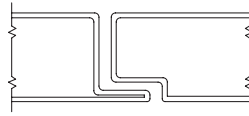

INTEGRAL ASTRAGAL

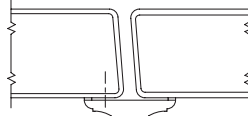

PARALLEL BEVEL
WITH MOLDED SURFACE ASTRAGAL

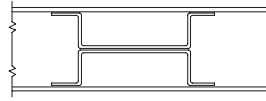

HAT SECTIONS



OFFSET CHANNEL

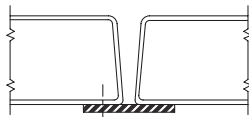

V-BEVEL
WITH FLAT SURFACE ASTRAGAL

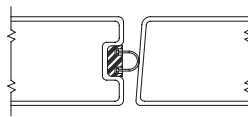

RECESSED
WEATHERSTRIPPING

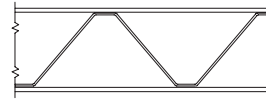

TRUSS

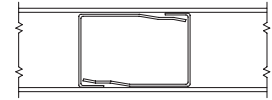

INTERLOCKING CHANNELS

B. MEETING EDGE PROFILES

C. STIFFENER SECTIONS

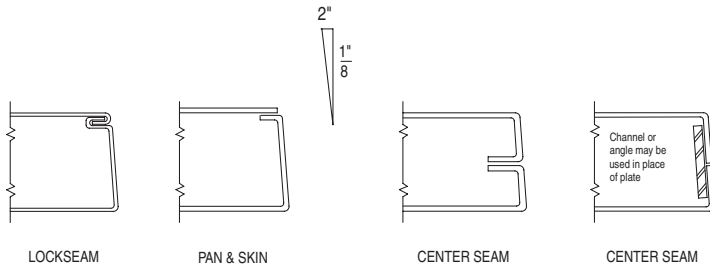

D. STILE EDGE DETAILS

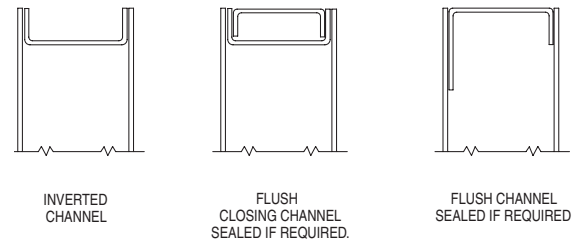

E. TOP EDGE DETAILS

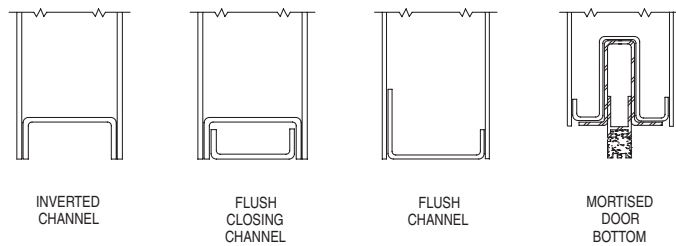

F. BOTTOM EDGE DETAILS

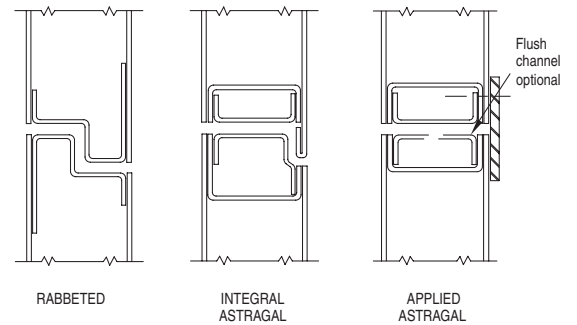

G. TOP EDGE DETAILS WITH FLUSH TRANSOM PANEL

H. GLAZED OPENINGS AND RECESSED PANEL MOULDINGS

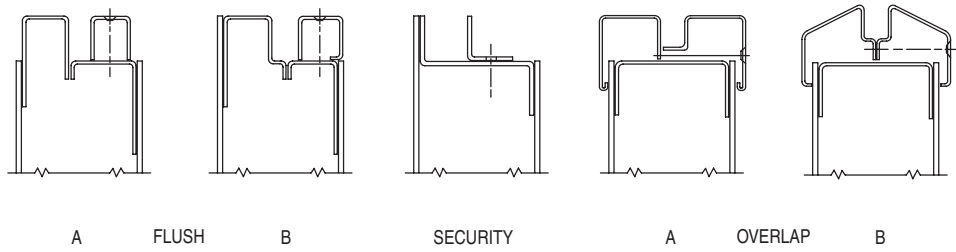

I. TYPICAL MUNTINS

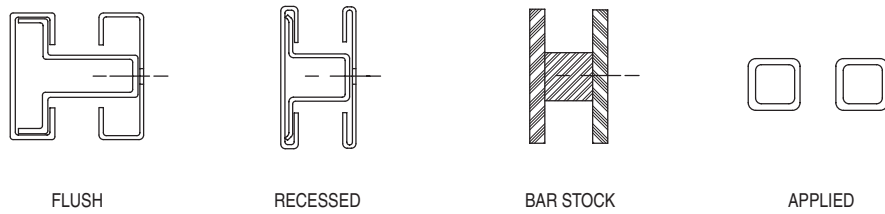

J. LOUVER DESIGNS

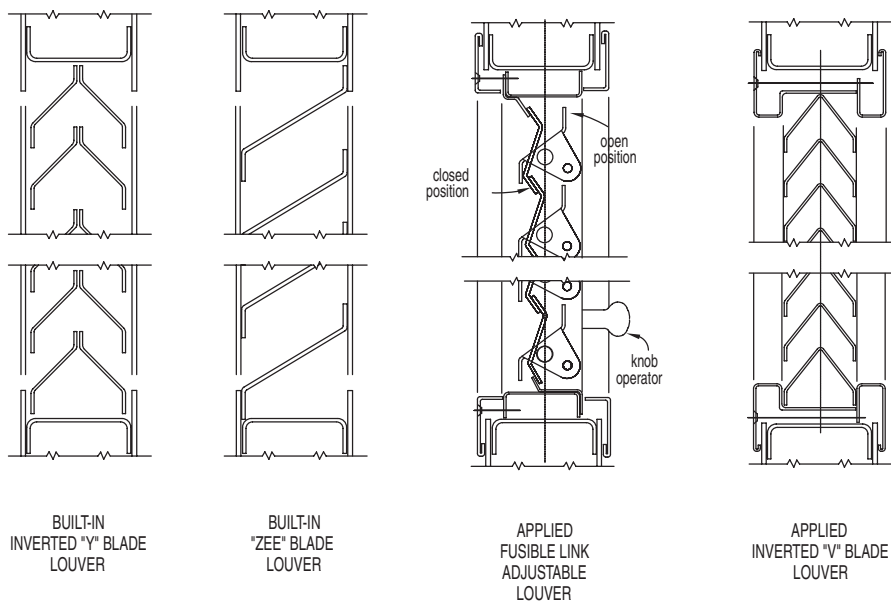

K. TYPICAL HARDWARE PREPARATIONS

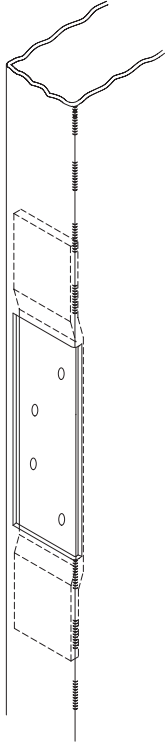

BUTT HINGE

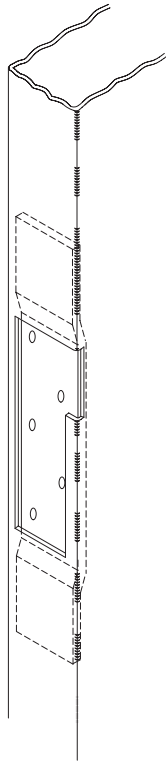

INTERMEDIATE PIVOT

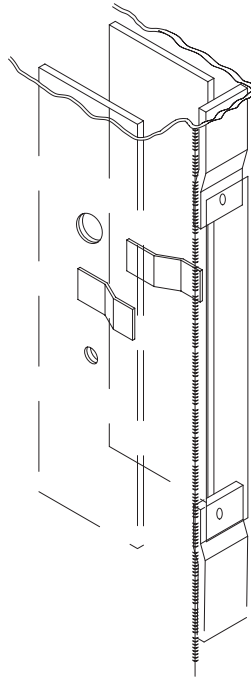

MORTISE LOCK

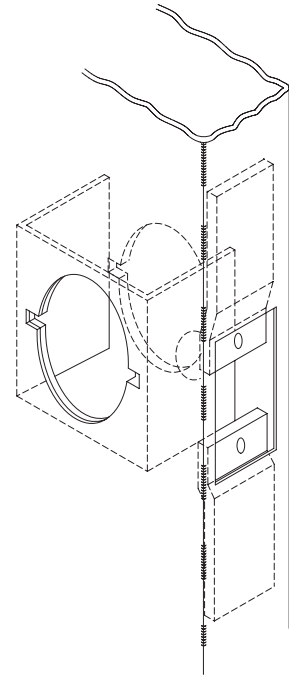

CYLINDRICAL LOCK

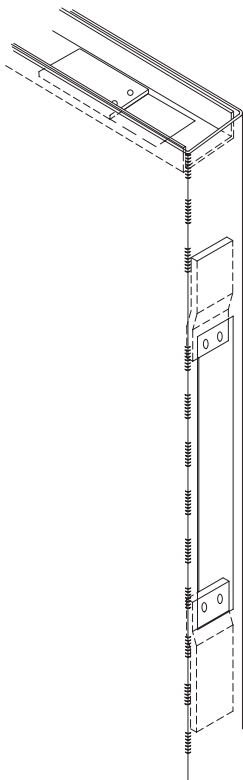

FLUSH BOLT

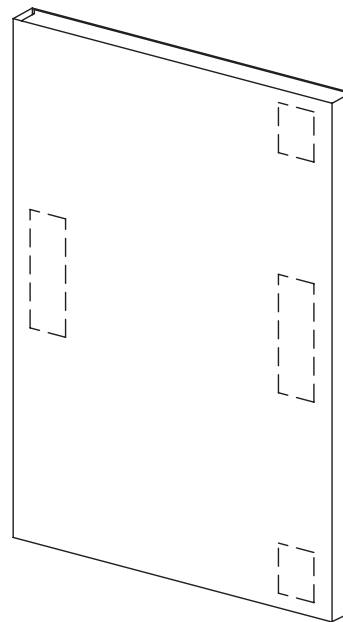

PANIC HARDWARE

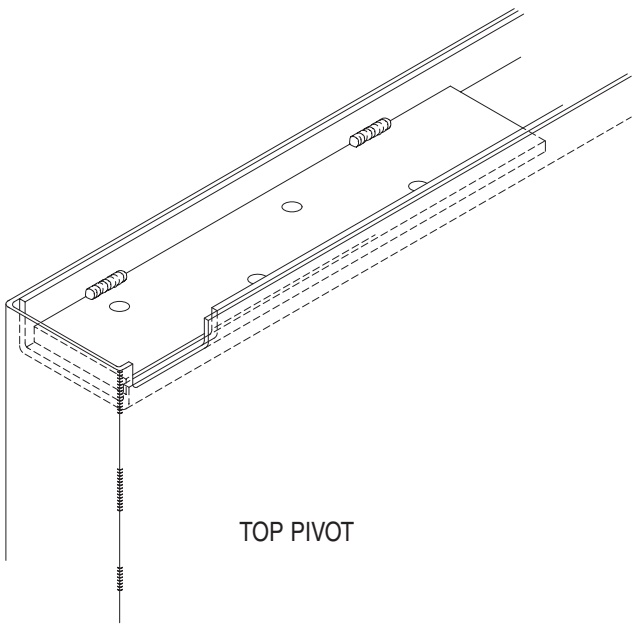

TOP PIVOT

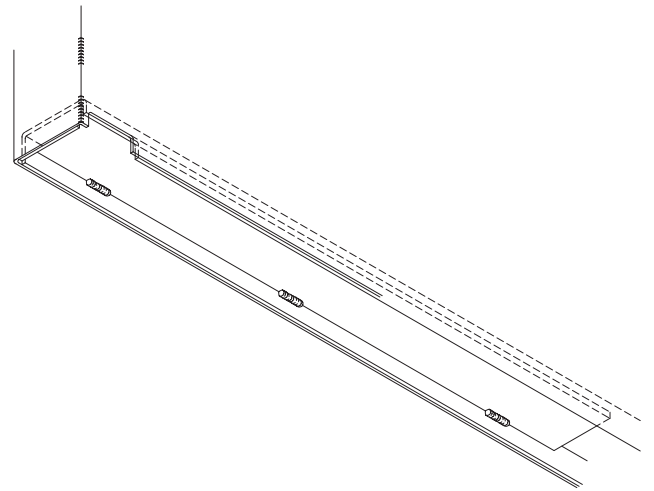

BOTTOM PIVOT

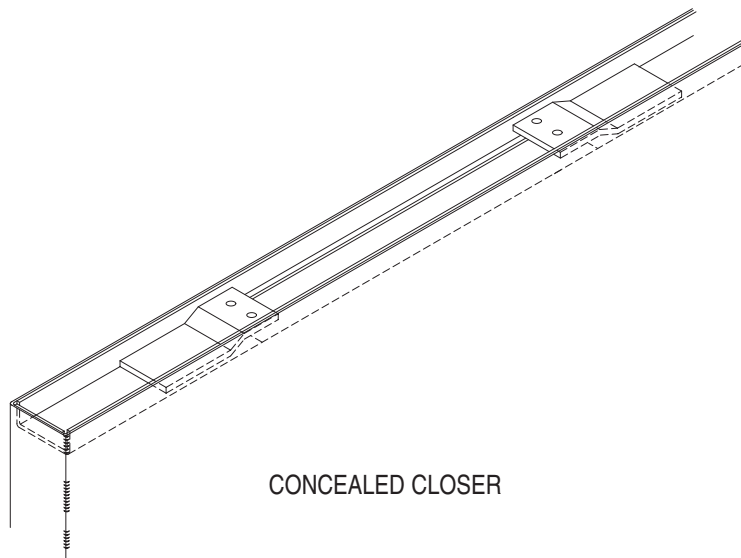

CONCEALED CLOSER

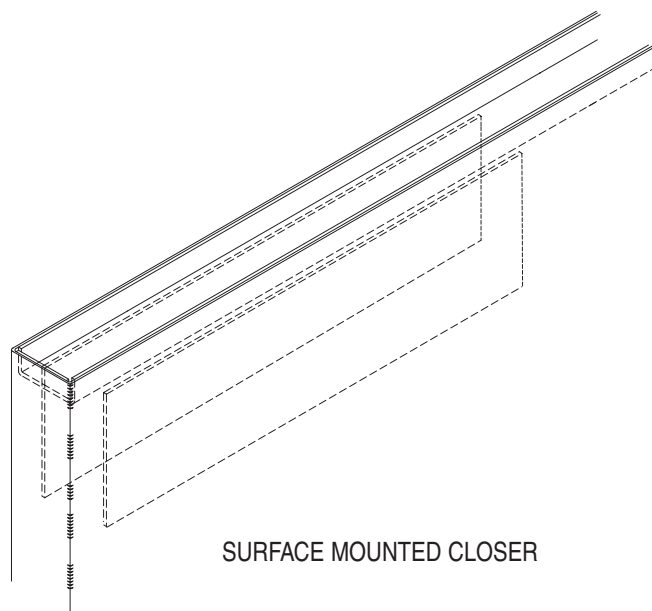

SURFACE MOUNTED CLOSER

RECOMMENDED GUIDE SPECIFICATIONS FOR HMMA HOLLOW METAL DOORS AND FRAMES

HMMA 860 — Hollow Metal Door and Frames

ANSI/NAAMM

HMMA 861 — Commercial Hollow Metal Doors and Frames

ANSI/NAAMM

HMMA 862 — Commercial Security Hollow Metal Doors and Frames

ANSI/NAAMM

HMMA 863 — Detention Security Hollow Metal Doors and Frames

ANSI/NAAMM

HMMA 865 — Swinging Sound Control Hollow Metal Doors and Frames

ANSI/NAAMM

HMMA 866 — Stainless Steel Hollow Metal Doors and Frames

ANSI/NAAMM

HMMA 867 — Commercial Laminated Core Hollow Metal Doors and Frames

RELATED HMMA DOCUMENTS

HMMA 800 — Introduction to Hollow Metal

HMMA 801 — Glossary of Terms for Hollow Metal Doors and Frames

HMMA 802 — Manufacturing of Hollow Metal Doors and Frames

HMMA 803 — Steel Tables

HMMA 810 — Hollow Metal Doors

HMMA 820 — Hollow Metal Frames

HMMA 830 — Hardware Selection for Hollow Metal Doors and Frames

HMMA 831 — Recommended Hardware Locations for Hollow Metal Doors and Frames

HMMA 840 — Installation and Storage of Hollow Metal Doors and Frames

HMMA 841 — Tolerances and Clearances for Commercial Hollow Metal Doors and Frames

HMMA 850 — Fire-Rated Hollow Metal Doors and Frames

HMMA 890 — Technical Summary

HMMA 810-TN01 — Defining Undercuts

HMMA 820-TN01 — Grouting Hollow Metal Frames

HMMA 820-TN02 — Continuously Welded Frames

HMMA 820-TN03 — Guidelines for Glazing Hollow Metal Transoms, Sidelights and Windows

HMMA 840-TN01 — Painting Hollow Metal Products